

Tools you need.

- ①Iron (30W)
- ②Solder wire
- ③Multimeter
- ④Tweezers
- ⑤Wire cutters

Precautions::

- ①Check part values & quantities against part list
- ②Always meter resistor values before soldering
- ③Understand all part polarities and orientations

EH-30 Electronic hourglass kit instructions

Rev. 1.0

2017. 11. 05

Produced by YiQi

1. Install MAIN RES:R31=1MΩ
Other resistors are 3.3KΩ

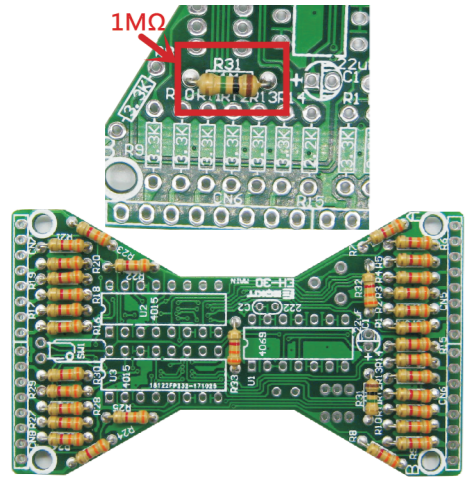

2. Install CAP:
C2=222P

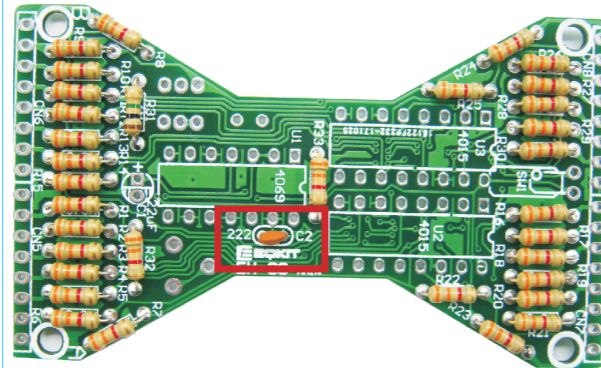

3. Install E-CAP:
C1=22uF, Notice that the positive electrode of electrolytic capacitor can not be reversed

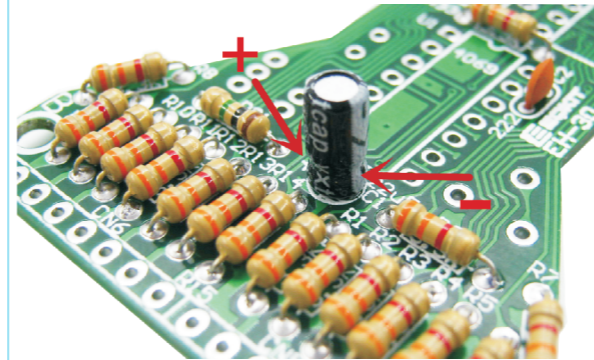

4. Install Directional switch :
Bend the switch 90 degrees, and then install it to SW1

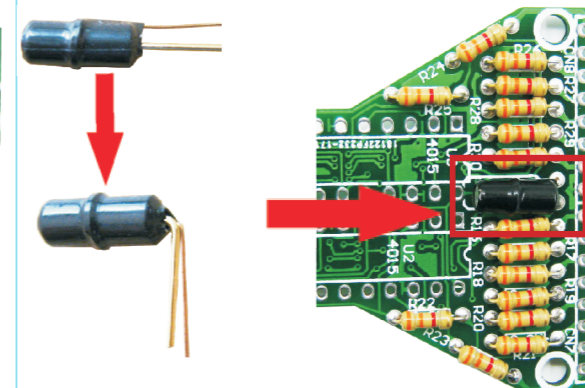

Warning
Light-emitting diode and electrolytic capacitor the longer pin is the anode it should be installed on the rectangle pad of PCB. Refer to the picture below

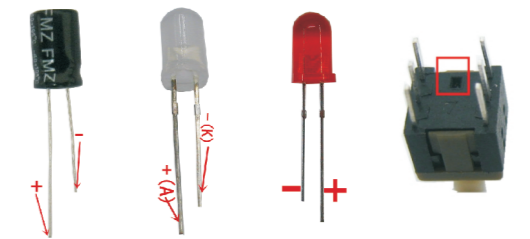

5. Install ADJ-RES:
VR1=104K, Note that the adjustable resistance should be soldered to the back of the circuit board

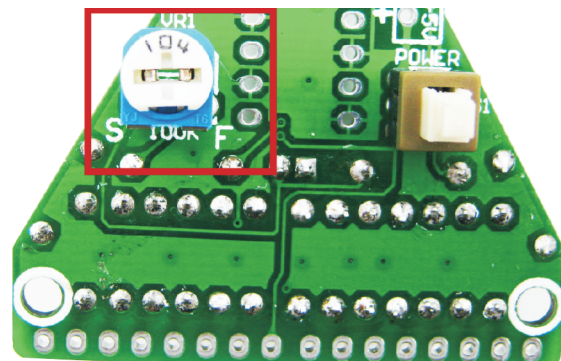

6. Install Power switch :
Pay attention to the installation direction of the switch

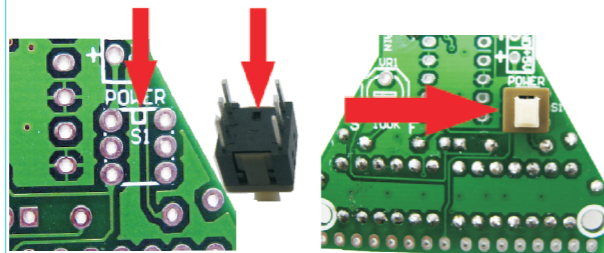

7. Install IC: Pay attention to the installation direction of IC.
U1=CD4069. U2=U3=CD4015

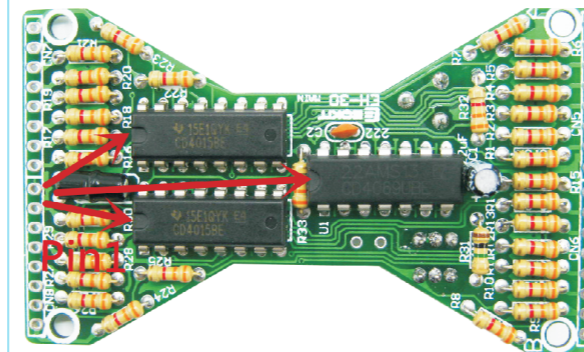

8. Install 8pin Connector :
Refer to the picture below: Install connector to CN5, CN6, CN7, CN8.

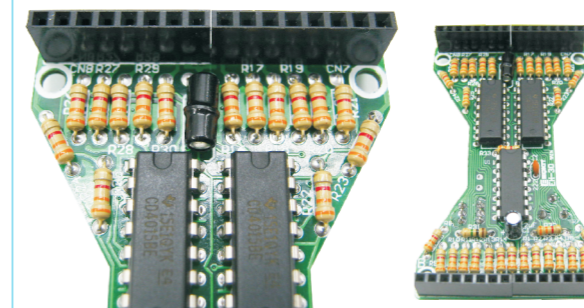

9. Install LED panel:

Install 30 LED on the circuit board
The long foot is the positive pole.
Install on the rectangle pad

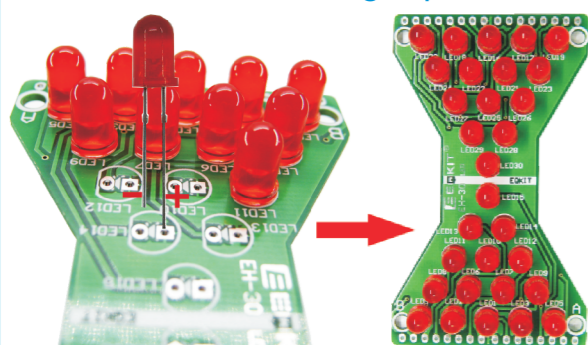

10. Install pin connector :
Install the short side of the connector to the back of the circuit board

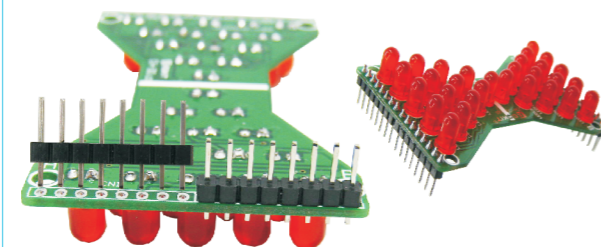

11. Install main and LED:
Install the motherboard and LED gently press together
A point to A, B point to B

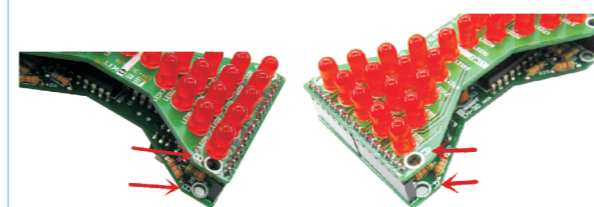

12. Welding power cable
Red line is positive power supply. Welding to +5V
The black line is the ground wire. Welding to GND.
Power supply DC5V. Suitable for USB.
3 section AA or AAA battery box

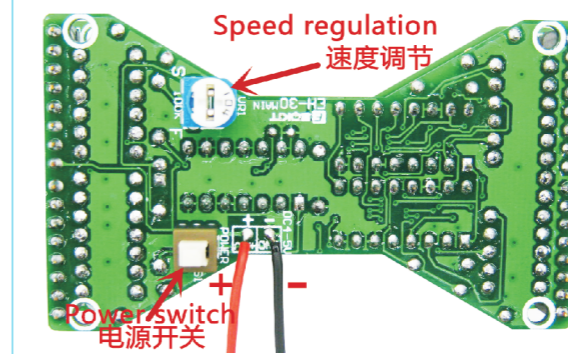

Installation list

EH-30 Electronic hourglass component list

NO.	Name	Parameter	QTY
R1-R30, R32, R33	RES	3.3K	32
R31	RES	1M	1
C2	CAP	222P	1
C1	E-CAP	22uF	1
LED-LED30	LED	5mm	30
U1	IC	4069	1
U2, U3	IC	4015	2
SW1	Directional switch	SW300DA	1
S1	Power switch	6P Auto lock	1
VR1	ADJ-RES	100K	1
CN1-CN4	Connector	8P	4
CN5-CN8	Connector	8P	4
—	PCB	EH-30-MAIN	1
—	PCB	EH-30-LED	1

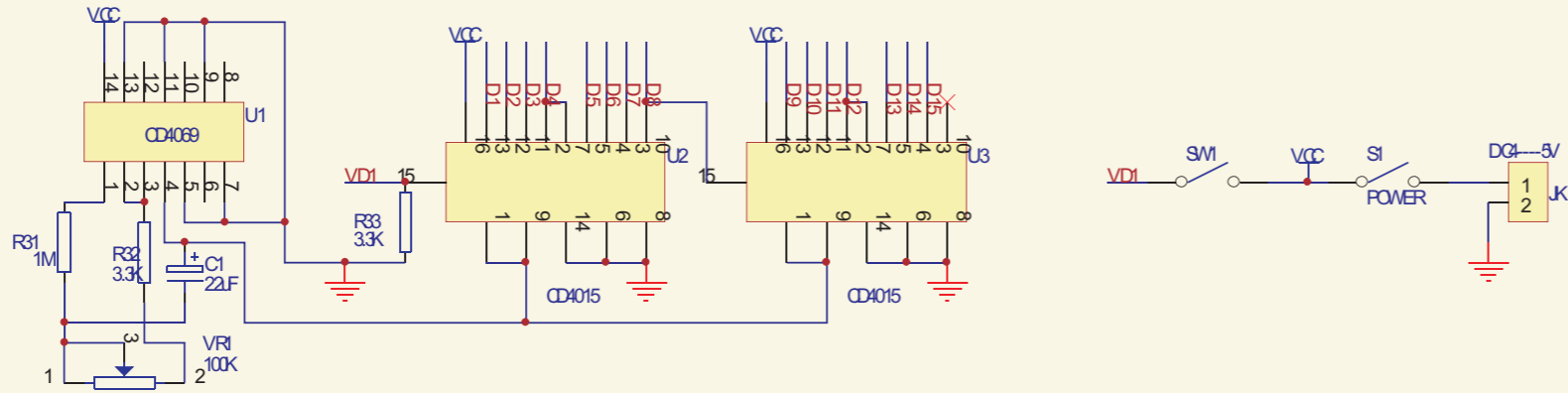
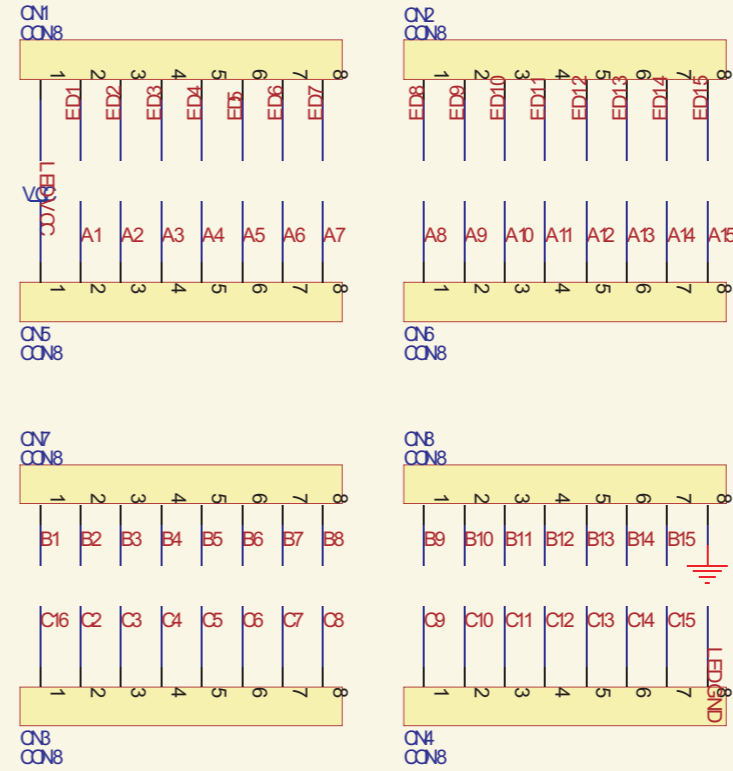
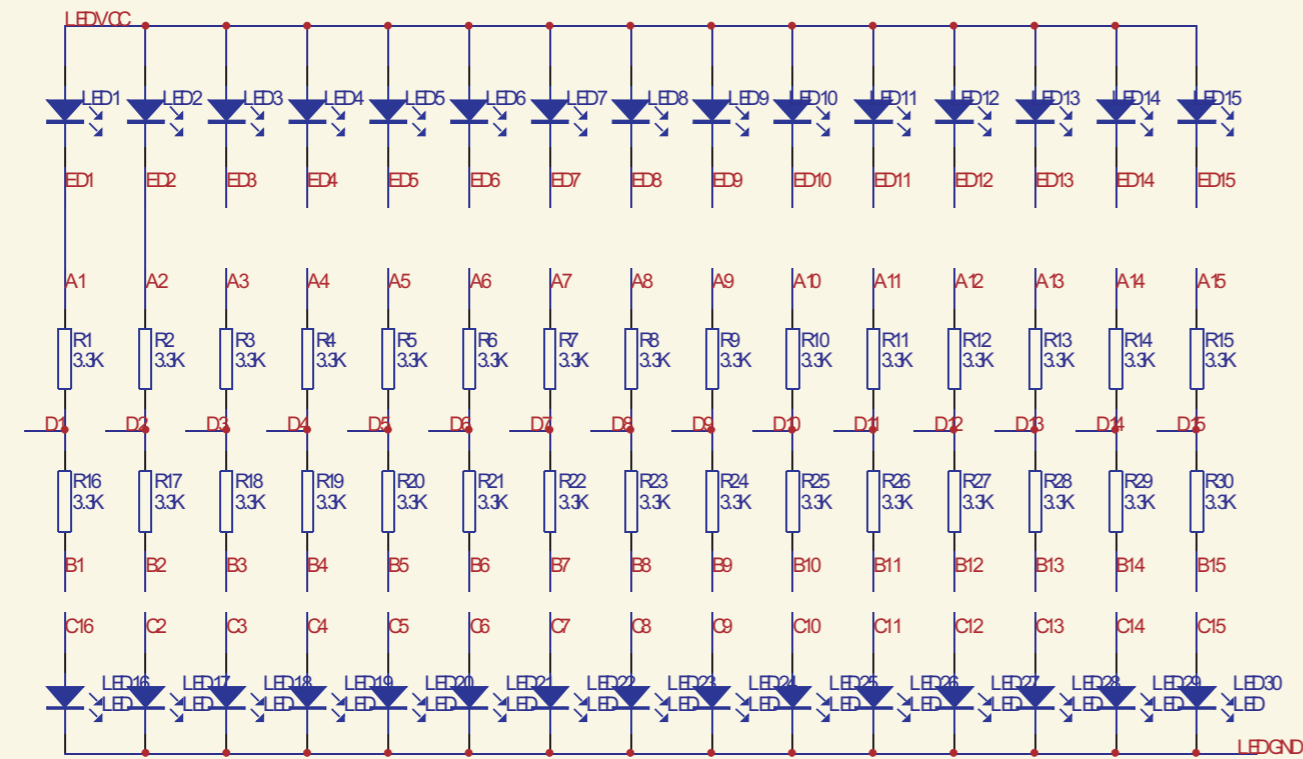

Title		
Size	Number	Revision
B		
Date:	5-Nov-2017	Sheet of
File	E:\vongyong.ctb	Drawn By: